

Univerza
v Ljubljani
Fakulteta
za gradbeništvo
in geodezijo



Jamova cesta 2
1000 Ljubljana, Slovenija
<http://www3.fgg.uni-lj.si/>

DRUGG – Digitalni repozitorij UL FGG
<http://drugg.fgg.uni-lj.si/>

V zbirki je izvorna različica izdajatelja.

Prosimo, da se pri navajanju sklicujete na bibliografske podatke, kot je navedeno:

University
of Ljubljana
Faculty of
*Civil and Geodetic
Engineering*



Jamova cesta 2
SI – 1000 Ljubljana, Slovenia
<http://www3.fgg.uni-lj.si/en/>

DRUGG – The Digital Repository
<http://drugg.fgg.uni-lj.si/>

This is a publisher's version PDF file.

When citing, please refer to the publisher's bibliographic information as follows:

Košir, M., Krainer, A., Dovjak, M., Perdan, R., Kristl, Ž. 2010 Alternative to the Conventional Heating and Cooling Systems in Public Buildings. *Strojniški vestnik - Journal of Mechanical Engineering* 56, 9: 575-583.

Alternative to the Conventional Heating and Cooling Systems in Public Buildings

Mitja Košir* - Aleš Krainer - Mateja Dovjak - Rudolf Perdan - Živa Kristl
University of Ljubljana, Faculty of Civil and Geodetic Engineering, Slovenia

The paper presents an alternative system for heating and cooling in public buildings. The system was designed for the retrofitted building of the Slovene Ethnographic Museum (SEM) where it was also extensively tested. The installed system includes radiant wall mounted panels for heating and cooling, localized automated tangential fans for cooling and ventilation and a centralized building management system for the regulation and supervision of the performance. The efficiency of the system was thoroughly investigated through a series of experiments conducted prior to the renovation of the building as well as after the museum was put into service. The application of the described system resulted in substantial reduction of energy consumption, better internal thermal conditions and lower investment costs for the Heating, Ventilation and Air Conditioning (HVAC) system of the entire building.

© 2010 Journal of Mechanical Engineering. All rights reserved.

Keywords: heating, cooling, ventilation, low temperature system, radiant panels

0 INTRODUCTION

The paper presents a system for indoor temperature regulation with the use of low-temperature radiant heating/cooling panels and automated natural ventilation. Extensive experimentation with the low-temperature wall mounted heating/cooling panels was conducted before and during the retrofitting of the Slovene Ethnographic Museum (SEM) in Ljubljana, Slovenia [1]. The in-situ experimental results, simulations and later measurements of the building performance in real time conditions proved high efficiency of the system. The wall mounted low-temperature radiant heating and cooling panels present an alternative to the air heating and air cooling systems originally proposed for the museum building. Because the majority of heat transport in the heated or cooled spaces equipped with low-temperature systems is conducted by radiation and not by convection, a smoother temperature profile preferred by the majority of users is achieved [2]. Low-temperature heating systems that operate close to the environmental temperatures are in addition to low energy also low exergy systems [3], although the use of high exergy fuels (e.g. electricity or fossil fuels) where low exergy work is needed somewhat reduces this effect. The previously proposed mechanical centralized ventilation was replaced by a localized automated ventilation

system utilizing small tangential fans integrated into the window sills. The system enabled the necessary physiological ventilation during museum opening hours as well as cooling via the night ventilation.



Fig. 1. North-east external view of the retrofitted museum building

The geometry of the museum building is presented in Fig. 2. Exhibition spaces equipped with panels are located in the east wing of the ground floor and on the 1st, 2nd and 3rd floors of the building; the total floor area is 2575 m², while the floor area of the entire building is 5214 m². The existing exterior walls were composed of external rendering applied to a 50 cm thick brick wall with internal rendering removed. Floors

*Corr. Author's Address: University of Ljubljana, Faculty of Civil and Geodetic Engineering, Chair for Buildings and Construction Complexes, Jamova cesta 2, Ljubljana, Slovenia, MKosir@fgg.uni-lj.si

were mostly brick vaulted, gravel filled and finished with wood decking.

1 CONCEPT OF HEATING/COOLING AND VENTILATION SYSTEM

The main objectives of the SEM – Museums project were to assure optimal conditions for exhibitions and for the storage of museum's exhibits in accordance with international standards, to assure appropriate environment for visitors from the visual and from the thermal point of view and rational use of energy without reducing the quality of functional use. When studying various options for achieving these goals, the decision was made that the problems had to be dealt with holistically (and not every aspect of internal conditions solved with a separate system) and that the rational use of energy for heating and cooling was to be achieved by reduction of operating costs controlled by a building management system (BMS).

There were seven main spheres of activities resulting in the framework of the following interventions: thermal energy with heating and cooling part, ventilation, daylight (not presented in this paper), control and management, constructional complexes, simulations, testing and measurements.

1.1 Heating and Cooling System

The design and performance of the wall mounted low-temperature heating/cooling system progressed through four distinct experimental phases. The conducted measurements spanned over four years, from those executed prior to the building renovation to those carried out during the first year of building operation [4] and [5]. The first phase of measurements (conducted during the summer and autumn months of 2000) encompassed the recording of values for the visual and thermal environment, while the building was un-refurbished and in "free run". The measurements showed that during summer season internal temperatures were maintained mostly within the 18 to 25 °C zone. Thermal mass of the building compensated for night lows (ΔT 10 K) and day highs (ΔT 4 K). During this time the possibility of installing a low-temperature heating and cooling system was discussed. The decision was made to investigate the effectiveness of such a system by conducting experiments in real environment of the building. The experience based on preliminary measurements and simulations also put in question the necessity of an air conditioning system proposed in the original design.

During the second phase of experiments

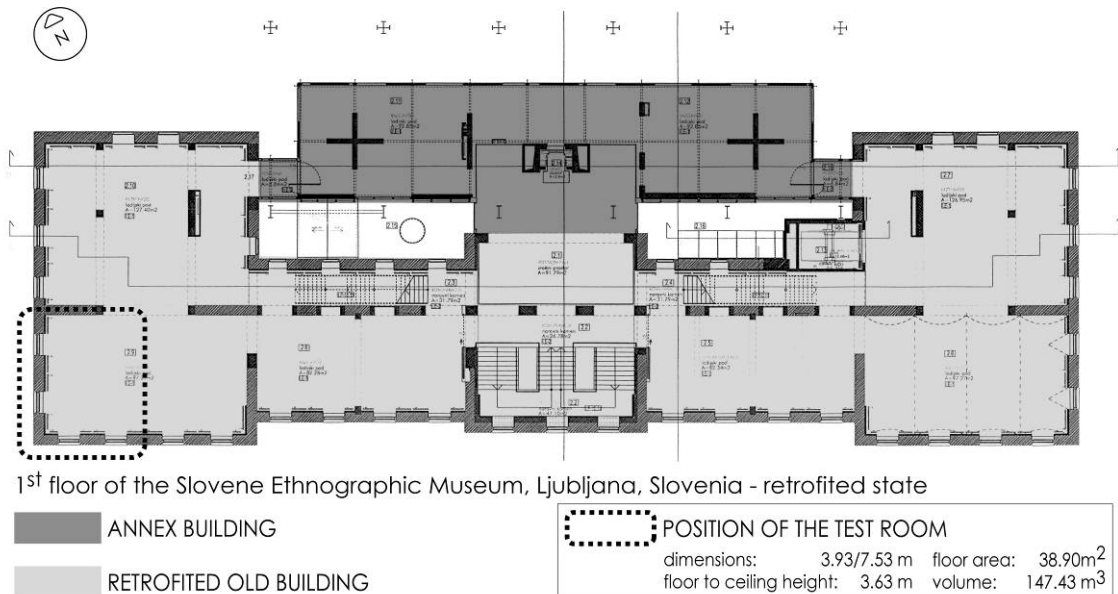

Fig. 2. 1st floor of the renovated SEM building

(conducted from the end of autumn 2000 till March 2001) the response of test rooms to various heating modes was tested. Two experimental test rooms were completely renovated in the SW corner in the 1st and 2nd floors (the position of the building is shown in Fig. 2). Both rooms were additionally thermally insulated and outfitted with new double glazed windows with low-e coatings as well as equipped with electrically powered heating units (conventional electrical radiators), as shown in Fig. 3. Measurements and computer simulations showed that annually the system would use 10 kWh/m² of heating energy less than the proposed air system [1], [4] and [5], if an alternative radiant system was to be used. In time for the beginning of the third phase of experiments (conducted from the end of March 2001 till July 2002) the prototypes of wall mounted heating/cooling panels were constructed and installed in the renovated test room on the 1st floor (dubbed the model room), while the second room on the 2nd floor (dubbed the reference room) remained the same as in the second phase (Fig. 4). Thorough measurements of wall panels were executed under real time environmental conditions. Example of results acquired during winter testing is shown in Fig. 5. For the model room the average energy consumption for heating was 12% lower than in the reference room. Difference in energy consumption between the two test rooms is the result of different temperatures of heating media and modes of heat transport. The cooling energy consumption was measured during two summer seasons, from August 2001 till June 2002. Different set point temperature series were tested: 24 h/day continuous cooling and two modes of intermittent cooling, from 08 to 20 h with 22.5 and 25 °C set point temperatures, respectively. Collected results were derived into seasonal specific cooling energy consumption between 10 kWh/m² (set point 25 °C) and 15 kWh/m² (set point 22.5 °C) for intermittent cooling and 25 kWh/m² (set point 25 °C) to 30 kWh/m², (set point 22.5 °C) for continuous cooling. Such low set point temperature was defined in order to test the cooling performance of the system and any possible occurrence of surface condensation. The acquired data showed important differences in energy consumption between the reference room

and the model room for heating and small specific energy consumption for cooling.



Fig. 3. Reference room on the 2nd floor of the SEM building heated with conventional radiator system



Fig. 4. Model room on the 1st floor equipped with the prototype heating/cooling wall mounted panels

In Fig. 5 daily temperature profiles for the model room during winter period (December) in intermittent heating mode are presented. The outside air temperatures were very low, between -15 and -3 °C which is low even for Ljubljana. In the diagram also the temperature profile for the reference room exhibiting a “wave” pattern is presented. In the model room the temperature profile is smooth and follows very well the prescribed set-point temperature profile. The experiments showed that the panels reacted well in winter, summer and mid-season conditions and consistently maintained the indoor temperatures close to the set-point temperatures without any difficulties.

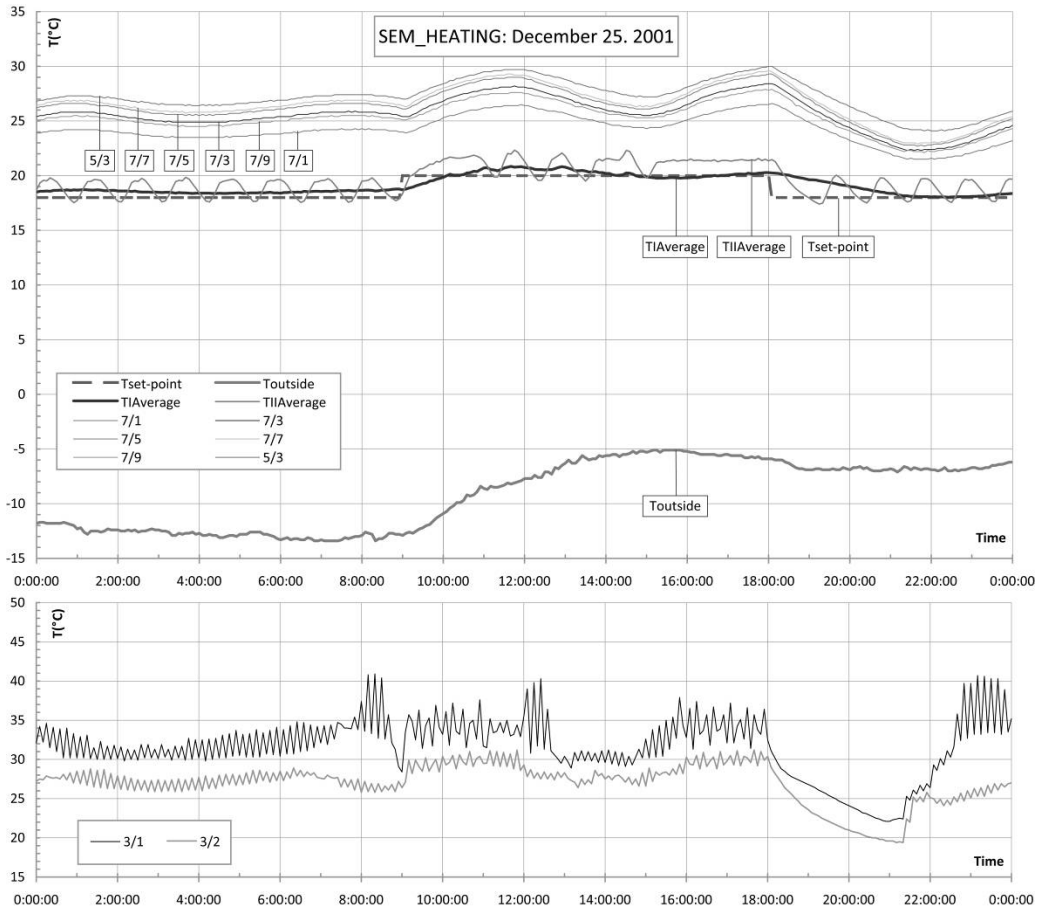

Fig. 5. Winter time experiment conducted in the model room during the 25th of December; shown are: external air temperature (*Toutside*), internal air temperature in the model room (*TIAverage*), vertical surface temperature distribution at the bottom of the panels (measuring nodes 7/1, 7/3, 7/5, 7/7, 7/9), core temperature of the panel (5/3), inlet (3/1) and outlet (3/2) water temperatures; as a reference the internal air temperature in the reference room (*TIIAverage*) and the set-point temperature (*Tset-point*) are shown

1.2 Ventilation System

For the ventilation of exhibition rooms new automated and localized natural ventilation system was designed. Small tangential fans were integrated into the window sills (Fig. 6) of new windows and were controlled with the BMS. The integration of the ventilation system with the window was necessary due to the minimal impact on the building exterior prescribed by the strict conservation standards.

The window integrated ventilation system is used for the necessary physiological ventilation during opening hours and for cooling purposes (night cross ventilation), when the conditions are

favourable. The cooling by ventilation system is harmonised with the functioning of the wall cooling system. Generally the wall cooling system is activated if the outside conditions do not enable cooling of the building with ventilation. The ventilation system also uses the microclimatic conditions surrounding the building in a way that optimizes the use of fresh air on internal comfort conditions. This means that during heating season the air is supplied from the south façade and expelled on the north side of the building. The situation is reversed during cooling season, as the supplied air is taken from the north side and expelled on the south side of the museum (Fig. 7).

2 FUNCTIONING OF SYSTEM IN THE BUILDING

2.1 Heating and Cooling

In the starting phase of the project no requirements for thermal insulation of buildings under historical monument preservation protection were foreseen. Firstly, the decision was made to place a 10 cm thermal insulation with the corresponding vapour barrier and plaster boards on the inner side of the existing outer brick wall. On one hand, this reduced the vast thermal mass of the building and on the other hand it reduced the U value of the outer wall from $1.16 \text{ W/m}^2\text{K}$ to $0.30 \text{ W/m}^2\text{K}$. With this intervention several benefits were gained. First, quick thermal response of the building was achieved, which enables effective intermittent heating and cooling. At the same time the outer side of the protected facade was not touched and it could retain its original structure and appearance. Second, low-temperature wall mounted heating/cooling vertical system was used. Third, non-manageable thermal mass of the original wall was excluded from the wall's thermal conduction transport system, but at the same time it was replaced by a designed thermal mass in the reinforced concrete wall panels separated from the other parts of the outer wall structure. Fourth, thermal comfort was improved due to the surface temperature to air temperature relation and lateral radiation effect. Fifth, consideration of the new design of combined heating/cooling wall panel system resulted in the decision to omit the designed air conditioning system. This sets free 158 m^2 of space for depository area, and the investment was reduced by about 100,000 to 150,000 euros.

2.2 Ventilation

Each floor is divided into two zones (east and west zones). A set of tangential fans is integrated into the sills of windows on the north and south side of the building. In zone 1 (ground floor, SE part of the building) there is a CO_2 sensor, triggering physiological ventilation during working hours when critical levels (700 ppm) are reached. The functioning of the ventilation in other parts of the museum is operated according to time dependent ventilation protocols that were

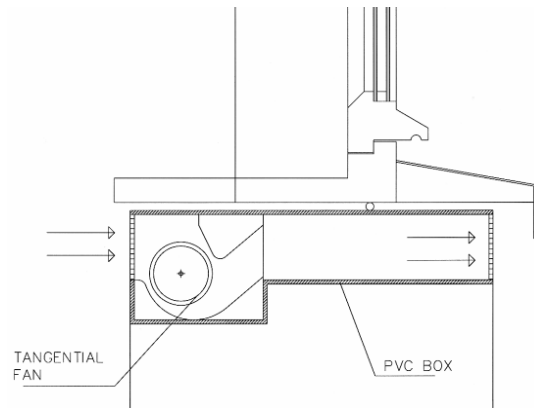

Fig. 6. Scheme of the tangential fan integrated into the window sill

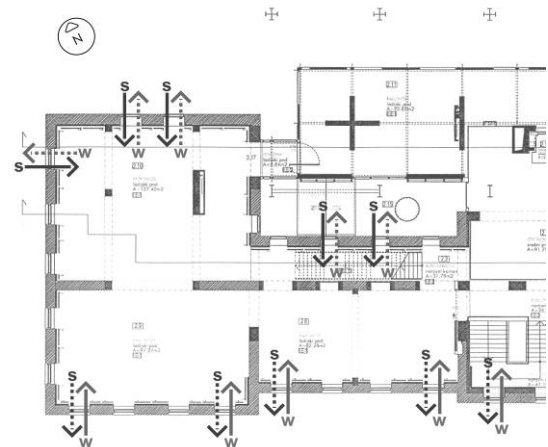

Fig. 7. Functioning of the localized ventilation system according to the seasonal microclimatic conditions (*W* – winter operation, *S* – summer operation, continuous line – supplied air, dotted line – expelled air)

derived from the measurements of CO_2 concentration in the SE part of the ground floor.

The fans of the ventilation system are also used for cross ventilation and cooling of exhibition rooms in the case of convenient outside temperature and relative humidity conditions. Cooling with ventilation is enabled when the external air temperature is 1 K lower than the internal set-point air temperature. If the cooling by ventilation is not sufficient (the internal air temperature is 1 K higher than the internal set-point air temperature), the system switches to the wall mounted cooling panels. In this case the fans are activated according to the physiological ventilation protocols.

2.3 Control and Management

Computer simulations of the building's energy consumption in the pre-retrofitted state showed the annual value of 156 kWh/m² of energy consumption for heating and cooling. This number was used as reference for the evaluation of energy performance of the building after the proposed interventions had been carried out. It was evident that the energy efficiency of the building could be improved with the application of the proposed interventions to the building envelope (installation of thermal insulation) and by using low-temperature heating and cooling system. If these interventions were considered in the TRNSYS [6] simulations, the reduction of heating and cooling energy consumption of 46.5% could be achieved in comparison to the reference state (Table 1). Simulation results predicted an annual energy consumption of 73 kWh/m² for heating and 10.5 kWh/m² for cooling, totalling at combined consumption 83.5 kWh/m² annually. The simulated energy consumption for the ventilation was predicted at 2.37 kWh/m² annually.

For the purposes of BMS the exhibition area with the total floor surface of 2884 m² is divided into seven zones: the East wing of ground floor and in the 1st, 2nd and 3rd floors (East and West zone in each floor), which are separately controlled by BMS. The scheme of the central control system and an example of opening BMS screen for heating-cooling panel system are presented in Figs. 8 and 9, respectively.

The heating system of the building is connected to the city district heating system. It is divided into 7 control zones (East part and West part of the building in each floor). Temperature/time/season sensitive BMS system is used and enables establishing of different set-point temperature profiles during opening and non-opening hours. During heating season the inlet water temperature was 35 °C with occasional peaks reaching 40 °C at times of extreme loads. For the cooling the wall mounted panels are connected to a common cooling plant (McQuay AGF-XN 070.2, cooling power: 218 kW, electric 88 kW, 2 compressors, 4 steps of 25, 50, 75, 100%). The temperature of cooled inlet water was typically kept around 15 °C with occasional lows of 11 °C. The same division of spaces as for heating is used for the control of

cooling. Temperature/time/season sensitive control wall mounted system is supplemented and harmonized with the ventilation cooling system. The activation of cooling panels is enabled when the external conditions do not allow cooling of the building via ventilation. Both systems are linked and harmonized. The possibility of manual override is foreseen for all zones. In addition to cooling purposes the localized automated ventilation system is also used for physiological ventilation of the museum. For physiological requirements daily/weekly regime of performance is executed. During visiting hours the air exchange level is set to 0.5 h⁻¹. This means that all fans in zones 2 to 7 (1st, 2nd and 3rd floor, East and West wings) are switched on every 15 minutes for the duration of 15 minutes. When the museum is closed, the ventilation is switched off. The East wing on the ground floor (zone 1) is ventilated according to the levels of CO₂ concentration.

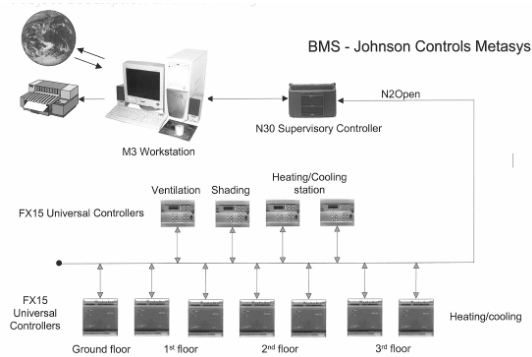

Fig.8. Scheme of the BMS.

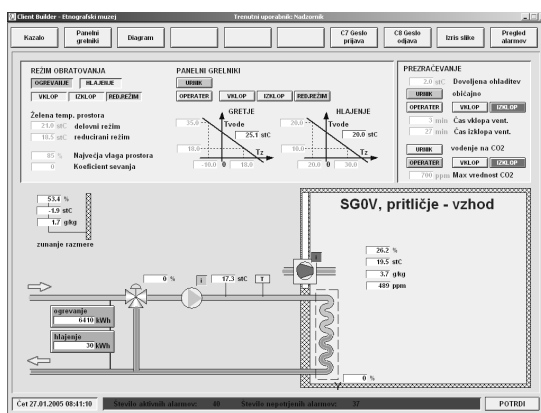

Fig.9. BMS screen with controls of the heating-cooling panels for the East wing of the ground floor. *(angleška besedila v sliki)*

Table 1. Results of simulations and measurements conducted during 2004 for the annual energy consumption of the exhibition part of the SEM; the pre-retrofitted reference state (simulated) energy consumption for heating and cooling was 156 kWh/m² annually

		SIMULATED RESULTS				MEASURED RESULTS (2004)				
		Q _h (heating)	Q _c (cooling)	Q _v (ventilation)	Q _h + Q _c (combined)	Q _h (heating)	Q _c (cooling)	Q _v (ventilation)	Q _h + Q _c (combined)	
[kWh/m ²]	Jan.	17.0	0.0	0.18	17.0	21.0	0.0	0.06	21.0	
	Feb.	12.0	0.0	0.18	12.0	12.7	0.0	0.06	12.7	
	Mar.	9.0	0.0	0.18	9.0	5.6	0.0	0.06	5.6	
	Apr.	3.3	0.0	0.18	3.3	1.3	0.0	0.06	1.3	
	May	1.0	0.0	0.18	1.0	1.0	0.0	0.06	1.0	
	Jun.	0.0	2.1	0.25	2.1	0.0	0.0	0.06	0.0	
	Jul.	0.0	4.2	0.25	4.2	0.0	5.6	0.19	5.6	
	Aug.	0.0	4.2	0.25	4.2	0.0	5.6	0.19	5.6	
	Sep.	0.0	0.0	0.18	0.0	0.0	0.0	0.06	0.0	
	Oct.	6.0	0.0	0.18	6.0	1.6	0.0	0.06	1.6	
	Nov.	9.0	0.0	0.18	9.0	3.8	0.0	0.06	3.8	
	Dec.	16.0	0.0	0.18	16.0	4.4	0.0	0.06	4.4	
		Annual	73.0	10.5	2.37	83.5	50.4	11.2	0.98	61.6
[%]	Annual reduction compared to the reference state					-46.5				-60.5

The BMS permanently controlled and collected the following quantities:

- **Microclimate:** ambient air temperature and humidity.
- **Energy Systems:** heating consumption (district heating, each zone separately and total consumption), cooling consumption (electricity), lighting consumption (electricity), total electricity consumption.
- **Indoor Comfort:** indoor air temperature and humidity, lighting levels.

Measurements of the whole building performance that were performed during the whole year 2004 were collected using installed BMS (Johnson Controls Metasys with FX15 Controllers) and the following sensors/meters:

- **Air temperature:** JC Series A99 sensors.
- **Air humidity:** JC Series HT-9000 sensors.
- **Heating/cooling energy:** Allmess, type CF Echo.
- **Electricity:** Iskra Instruments, d.d., type WS1202.
- **CO₂:** Siemens, type QPA63.1.

Protocols for on-line monitoring of the control system during the operation of the building were prepared for different day-night, summer-winter regimes, for different sources: heating-cooling panels for heating and cooling

function, physiological ventilation, for the combination of cooling and relative humidity with corresponding descriptions of interventions in tabular form. The following information is available and stored by the BMS during the operation of the building:

- **Review of conditions on PC:** outside air temperature and relative humidity, temperature and relative humidity in zones, temperature of heating medium by zones, energy use (heating, cooling), daily/seasonally by zones, electrical energy use daily/seasonally by zones, condition of panels and ventilators, both for the part of the building treated in the framework of the MUSEUMS project and for the other part of the SEM exhibition building.
- **Possibilities of data storage on PC:** outside temperature and relative humidity (hourly average), temperature and relative humidity by zones (hourly average), temperature of heating medium by zones (hourly average), energy use (heating, cooling), full hourly data, electrical energy use, full hourly data, condition of panels and ventilators.

There were two different energy use patterns during the measurements conducted in 2004, the first in the beginning and the second at the end of the year. In the first part energy

consumption was higher by 8.6% in the part of the museum with installed wall panels than in the rest of the building. During this period the controller maintained constant heating media temperature for 24 hours per day for the whole building. In the second part of the heating season the wall panels functionality was optimized by the BMS which resulted in 5 times smaller consumption in December 2004 compared to January 2004 (Fig. 10).

3 CONCLUSION

Low-temperature radiative heating and cooling systems represent an efficient solution for creating good thermal environment. Low-temperature systems enable the transport of heat through radiation and this eliminates the problems of user discomfort due to annoying air movement [2]. In addition to better thermal comfort of users such systems also exhibit improved energy efficiency due to utilization of lower temperatures of heating and/or cooling medium, which results in direct energy savings due to better boiler efficiency and lower thermal losses of the entire system [7]. Nonetheless, systems that utilize low temperatures of heating and cooling medium have special configuration compared to conventional systems. The most obvious difference is that large surfaces have to be heated or cooled for efficient functioning.

In the case of the SEM optimal relation between air temperature and surface temperature in the museum building is achieved with the use of heating/cooling wall mounted panels. They represent the main intervention in the framework of the construction. The system is connected to the district heating system for heating purposes in winter and to cooling plant for cooling purposes in summer. Window integrated BMS controlled ventilation system (small tangential fans) is used for the necessary ventilation during opening hours and for cooling purposes (night ventilation), harmonised with the wall cooling system.

Due to "high risk" nature of the proposed innovative heating/cooling system a series of experiments were conducted in various phases of its development. On the basis of these findings the decision for using the proposed system in the exhibition area of the building was adopted. After the execution of the planned interventions and the installation of the heating/cooling and ventilation system, the building was put into operation. The performance of the building was closely monitored during the whole first year (2004) of the museums operation. The actual measured energy consumption of the heating system was even lower than had been indicated by the computer simulations, as the exhibition area that encompasses approximately one half of the museum floor spaces consumed only 14% of the total heating energy consumption of the whole building.

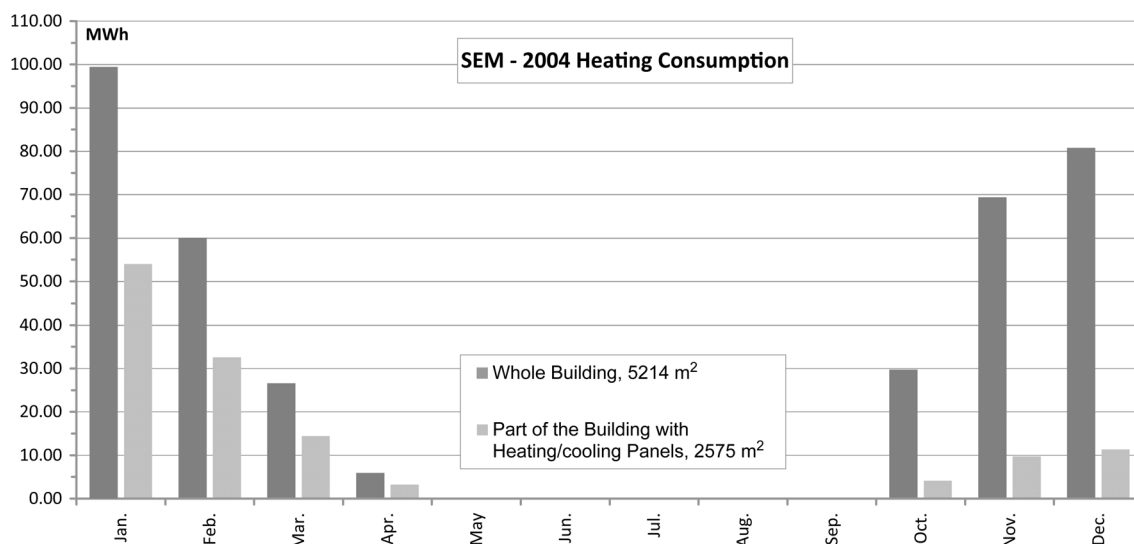

Fig. 10. Heating energy consumption of the low-temperature wall panels installed in the exhibition space compared to the overall consumption of the whole SEM building

The most important, difficult and problematic part of the project was design and tuning of harmonised control of temperatures, relative humidity, CO₂ and cooling oriented ventilation with the application of central control system designed specially for this project. In the end the gross energy demand for heating and cooling is reduced by 60.5% (Table 1), from 156 kWh/m² annually (simulated pre-renovation state with presumed continuous heating) to 61.6 kWh/m² annually (measured - combined energy consumption for heating and cooling). The average measured consumption in similar buildings is usually more than 140 kWh/m² annually (based on simulated cases). The selection of a localized automated ventilation system integrated under the window resulted in a negligible quantity of only 0.98 kWh/m² of energy used for ventilation purposes per year. The quantity of the foreseen blown-in air was reduced from 36500 m³/h (predicted in the original project) to 10000 m³/h (implemented system). The power of heating station was reduced by 110 kW and for cooling by 62 kW.

The result of the project is also the reduction of the investment budget in the field of HVAC from € 530,319 to € 434,075 [1], [4] and [5]. As a result of the installation of the wall mounted heating/cooling system and window integrated ventilation system 158 m² of floor space were liberated for critical deposit area. The introduction of heating-cooling wall panels resulted besides in considerable energy reduction also in better indoor comfort because of large vertical heating and cooling areas with optimal surface temperatures.

The obtained results pointed to the importance of proper system regulation and automatic control [8], as realised energy savings would not be possible without sufficient control provided by the BMS. In the end the use of wall-mounted heating/cooling system in a renovated building also showed that successful use of low-temperature systems can be achieved in retrofitting projects if they are well coordinated throughout the project activities.

4 ACKNOWLEDGEMENT

This project has been supported by the European Commission 5th Framework Programme MUSEUMS Energy Efficiency and Sustainability in Retrofitted and New Museum Buildings, NNE5/1999/20, Ministry of Education, Science and Sport, Republic of Slovenia, Research Programme Renewable Energy Sources, P0-504-0792-02 and Chair for Buildings and Constructional Complexes, Faculty of Civil and Geodetic Engineering, University of Ljubljana, Slovenia.

5 REFERENCES

- [1] Krainer, A., Rudi, P. (2005). *Slovene Ethnographic Museum*. Slovene Ethnographic Museum, Ljubljana.
- [2] Imanari, T., Omori, T., Bogaki K. (1999). Thermal comfort and energy consumption of the radiant ceiling panel system: Comparison with the conventional all-air system. *Energy and Buildings*, vol. 30, no. 2, p. 167-175.
- [3] Asada, H. (2004). Exergy analysis of low temperature radiant heating system. *Building Service Engineering Research and Technology*, vol. 25, no. 3, p. 197-209.
- [4] Krainer, A., Perdan, R., Krainer, G. (2007). Retrofitting of the Slovene Ethnographic Museum. *Bauphysik*, vol. 29, no. 5, p. 350-365.
- [5] Krainer, A., Perdan, R., Krainer, G. (2006). Slovene Ethnographic Museum: SEM, a case study. *International Journal of Sustainable Energy*, vol. 25, no. 3, p. 131-151.
- [6] TRNSYS. *A transient System Simulation Program*, version 15.0. Solar Energy Laboratory, The Centre Scientifique et Technique du Batiment, Transsolar Energietechnik GmbH and Thermal Energy Systems Specialists, 2002.
- [7] Paić, Z. (2002). *Sustavi površinskog grijanja i hlađenja*. Energetika marketing, Zagreb.
- [8] Košir, M. (2003). Integrated regulating system of internal environment on the basis of fuzzy logic use: *doctoral thesis*, Ljubljana: University of Ljubljana, Faculty of Civil and Geodetic Engineering.